

iCON – Settings for ISUB22 0.75kW 240V 3PH

4.1A

- iCON Series Drives

– Programming Basics

Unlocking the drive

1. Press the PRG/ESC button
2. Then press the DATA/ENT button twice and 00000 will appear on the screen.
3. Using the scroll keys enter the following password 65535 and push DATA/ENT to unlock the first level of the menu system
4. Press the PRG/ESC key to return to first level

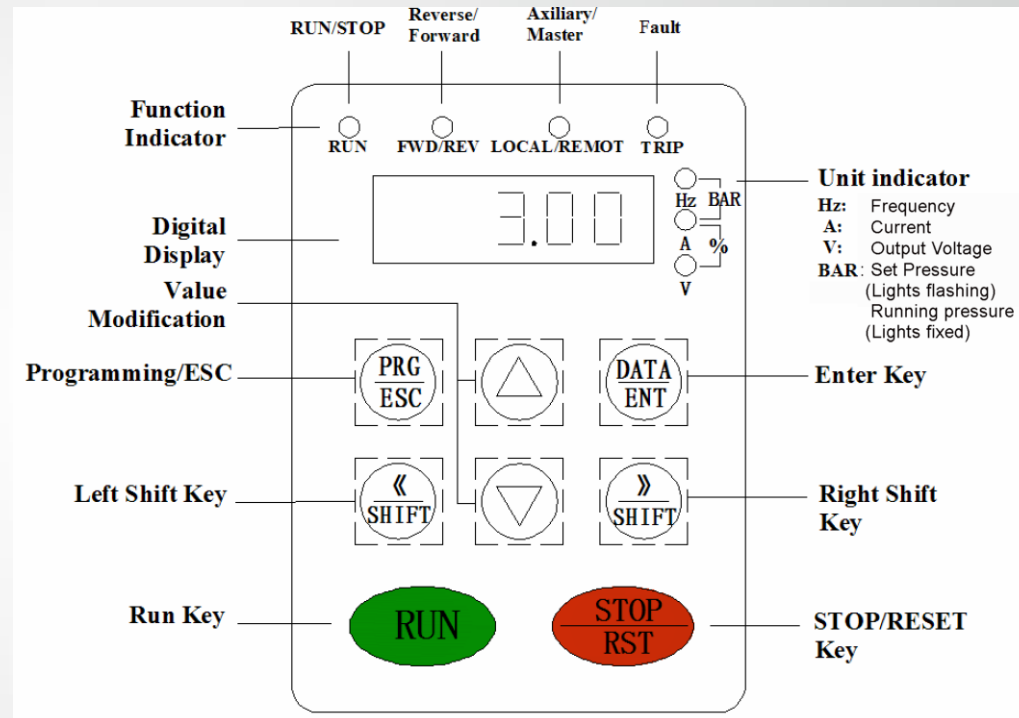

iCON – Settings for ISUB22 0.75kW 240V 3PH

4.1A

- iCON Series Drives

- Programming Basics

Unlocking the drive

5. Press the **PRG/ESC** key and **B00** will appear using the scroll keys scroll to **B07** and press the **DATA/ENT** Key and **B07.00** will appear
6. Using the scroll key scroll to **B07.15** and **00000** will appear
7. Using the scroll keys enter the following password **65535** and push **DATA/ENT** to unlock the last level of the menu system
8. Press the **PRG/ESC** key to return to first level

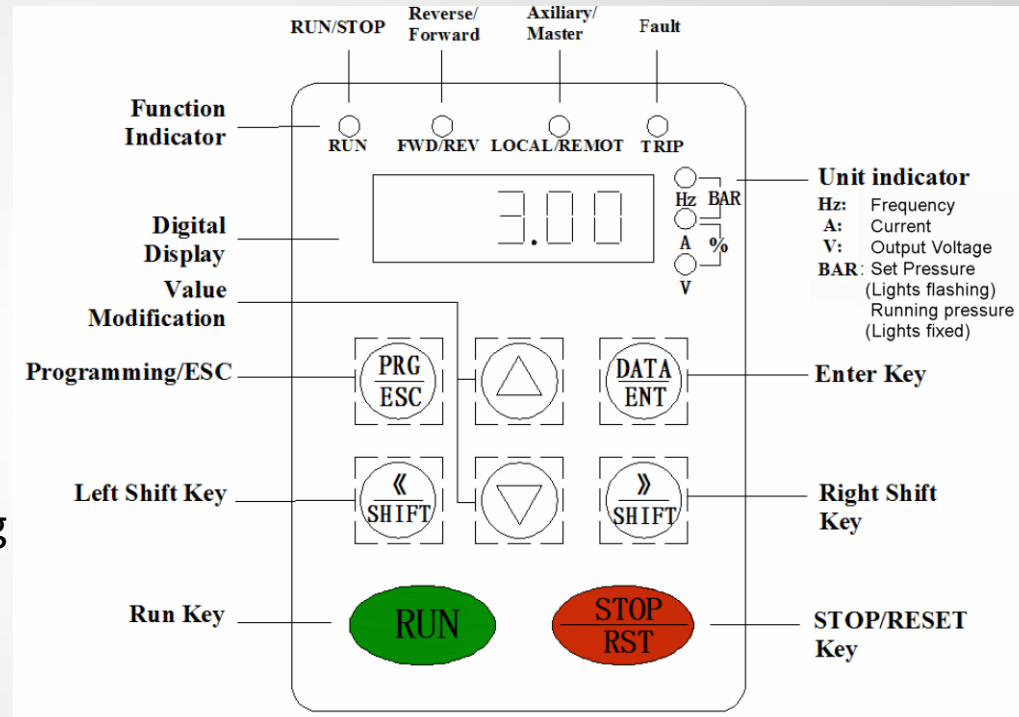

iCON – Settings for ISUB22 0.75kW 240V 3PH 4.1A

- iCON Series Drives
 - Programming Basics

Setting the Motor configuration

1. Press the **PRG/ESC** key and the last menu level will appear using the scroll keys scroll to **B08** and press the **DATA/ENT** Key and **B08.00** will appear
2. Using the scroll key scroll to each of the following settings press the **DATA/ENT** key to configure the setting and the **PRG/ESC** key to save and return to the previous menu to enter further configuration requirements

BR08.01	Motor rated power in kW	As per motor plate in kW (0.8)
BR08.02	Motor rated Frequency	50hz
BR08.03	Motor Rated Speed	2850 RPM
BR08.04	Motor Rated Voltage	230v
BR08.05	Motor Rated Amperage	As per motor plate (4.1)
BR05.07	Lower frequency limit	31hz
BR05.00	Water Level control	Set to 0
BR05.03	Acceleration time	Set to 1.0 Seconds
BR05.04	Deceleration time	Set to 1.0 seconds
BR00.02	Motor Direction	As default unless required (CHECK ON INSTALLATION)

iCON – Settings for ISUB22 0.75kW 240V 3PH

4.1A

- iCON Series Drives
 - Programming Basics

Setting the required system settings (refer to manual)

1. Press the **PRG/ESC** key and the last menu level will appear using the scroll keys scroll to **B level you require** and press the **DATA/ENT** Key to enter the level you require
2. Using the scroll key scroll to each of the required settings press the **DATA/ENT** key to configure the setting and the **PRG/ESC** key to save and return to the previous menu to enter further configuration requirements

System Settings

BR00.01	Operational pressure	3.0bar (or as per your requirement)
BR01.16	System Auto Restart	Set to 1
BR00.03	System Anti Freeze	Set to 0
BR00.04	System anti block	Set to 0
BR04.00	System sleep mode	Set to 1
BR04.01	Sleep delay in seconds	Set to 5.00
BR04.03	Sleep Wake up Differential	Set to 0.5
BR04.04 (not applicable 1ph/1ph)	Sleep Stop Differential	Set to 0.4